

SÈRIE 3

Exercici 1

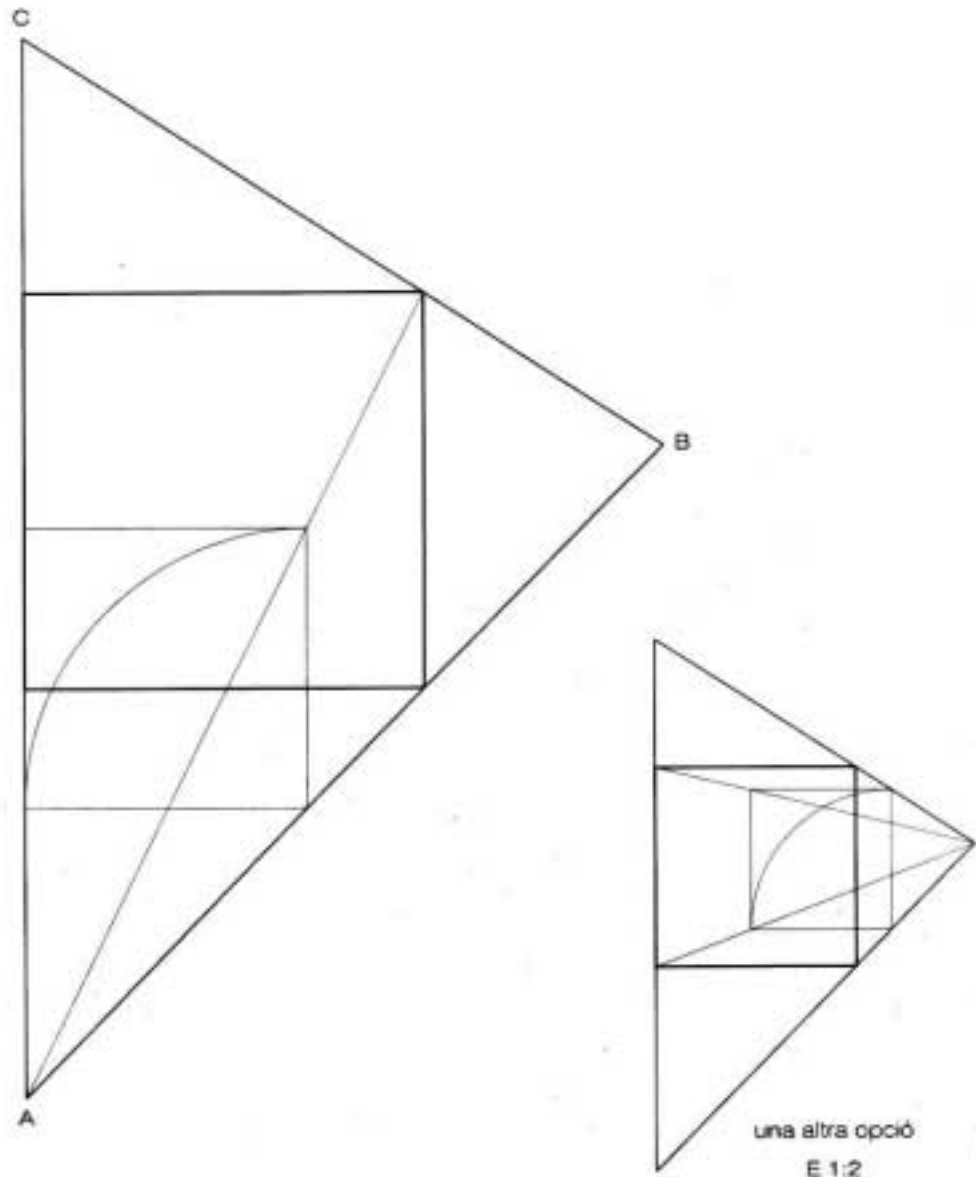

## Exercici 2 Opció A

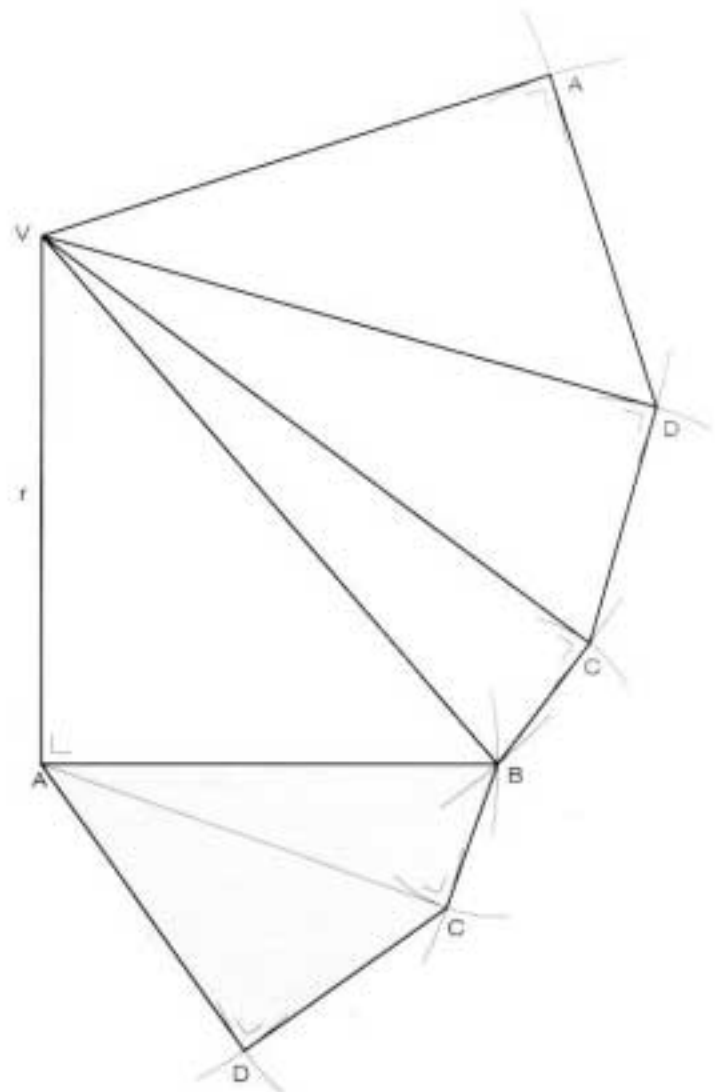
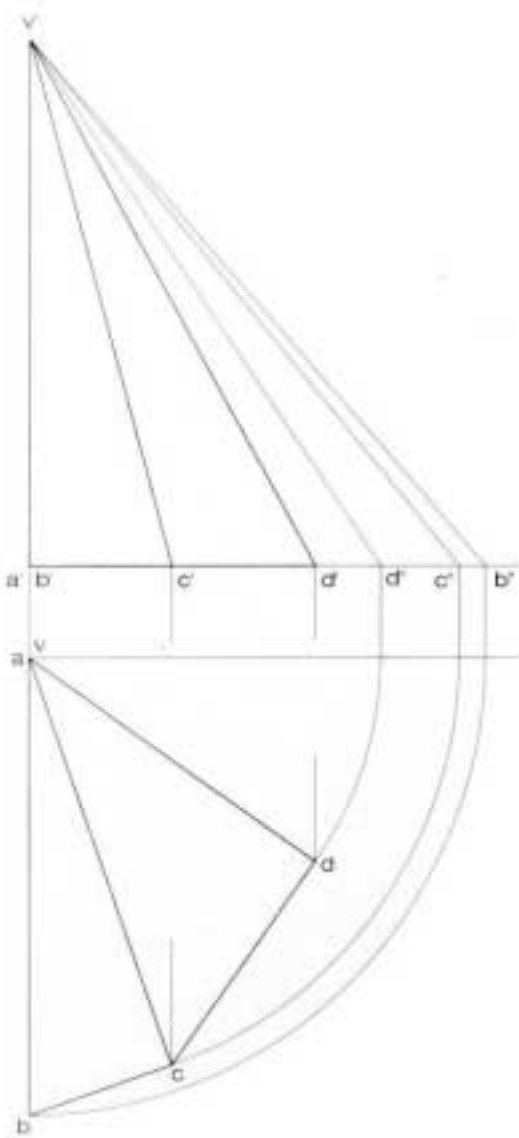

totes quatre cares són triangles rectangles

### Exercici 2 Opció B

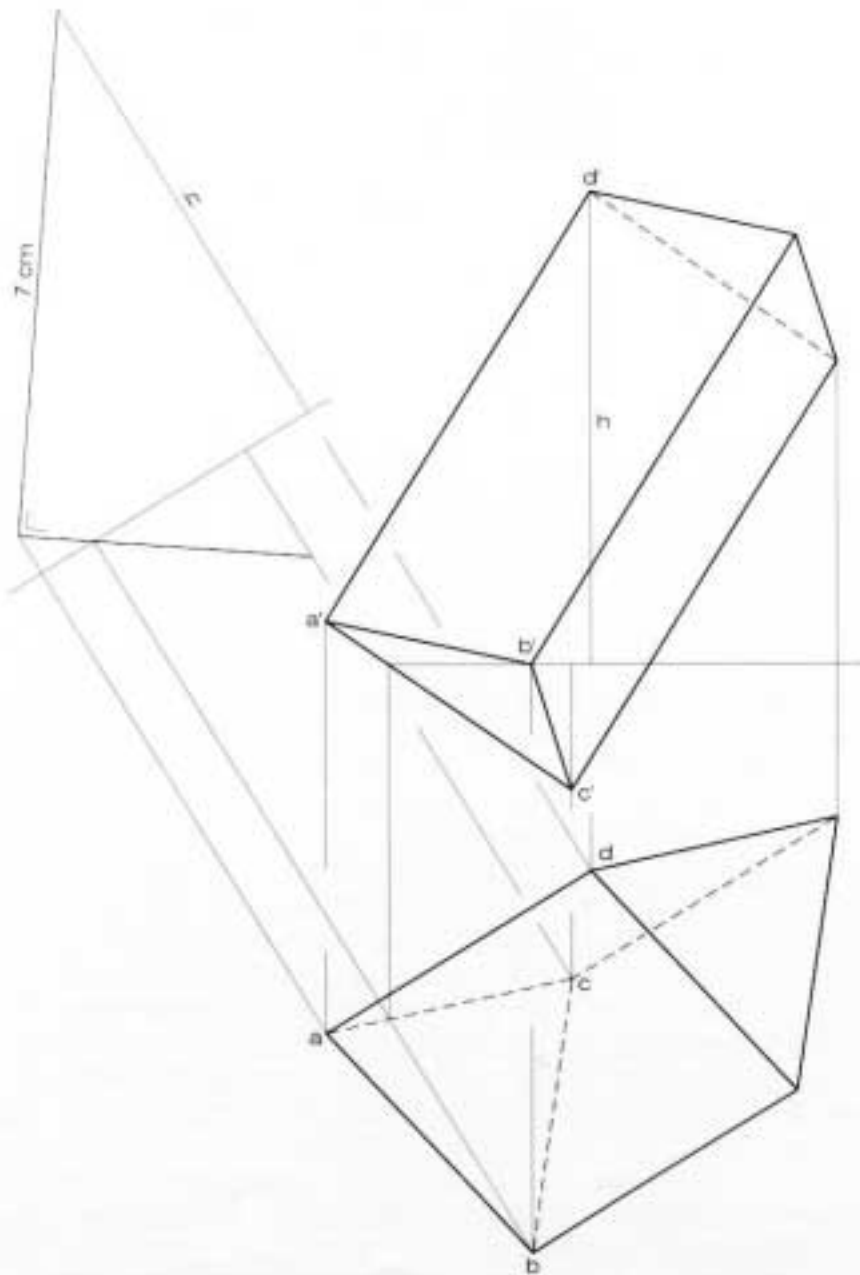

### Exercici 3 Opció A

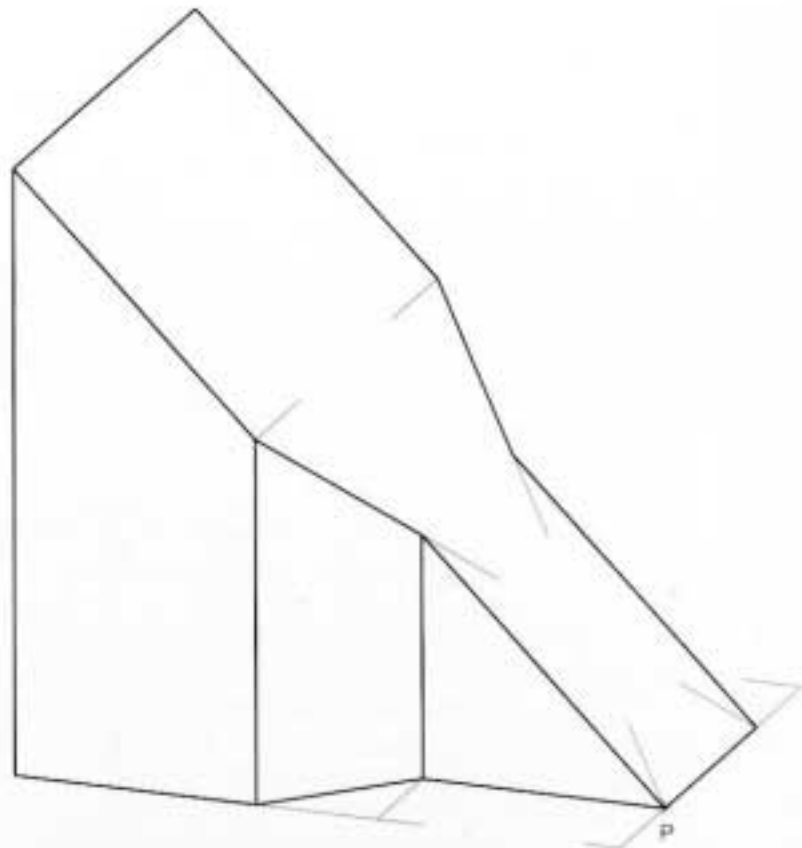
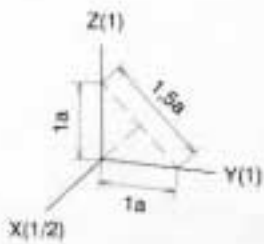
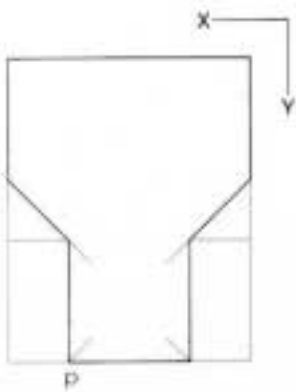
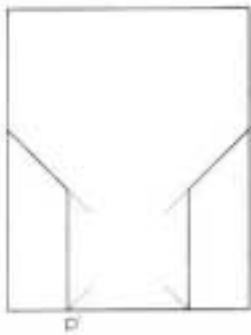

### Exercici 3 Opció B

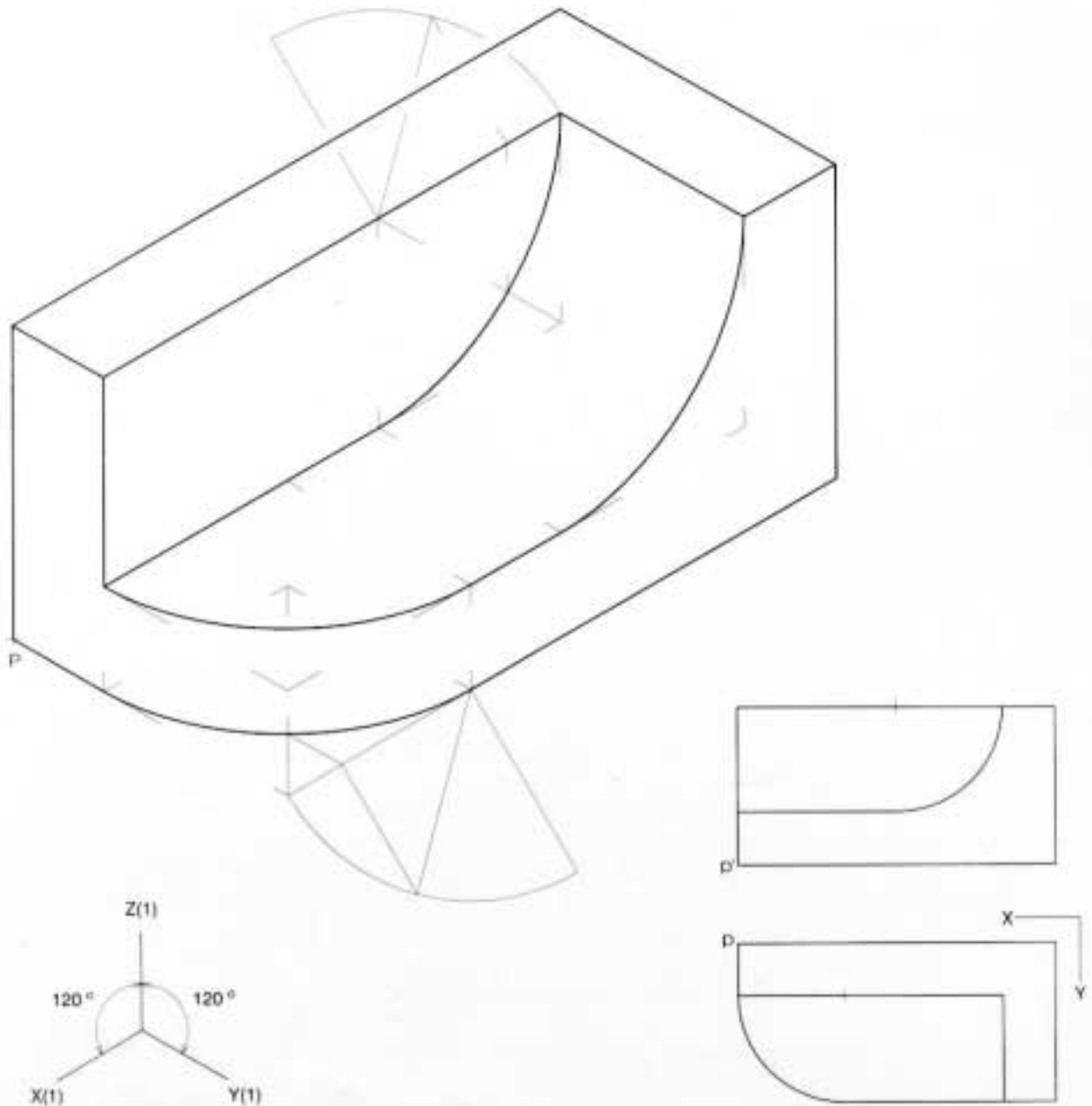



## Exercici 2 Opció A

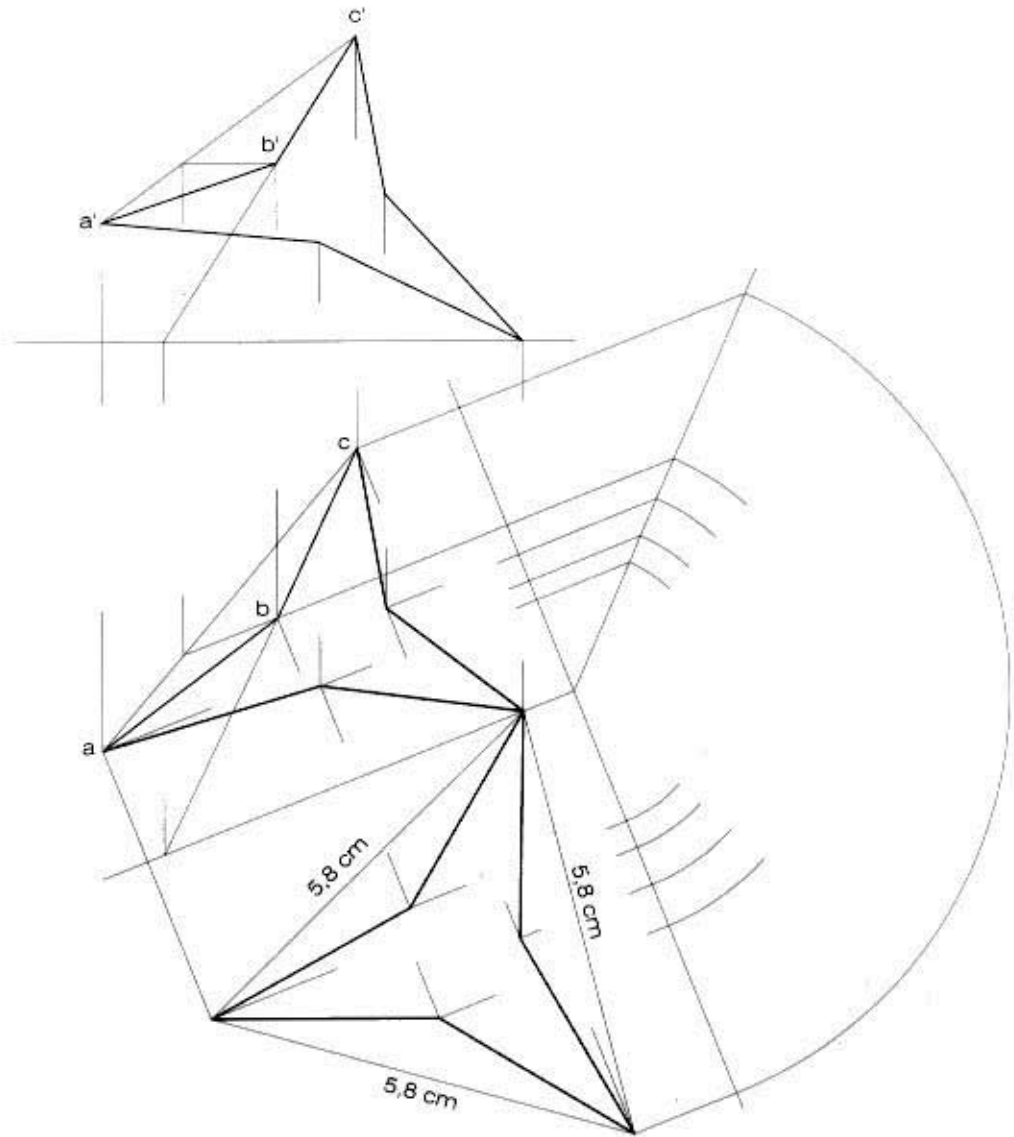

## Exercici 2 Opció B

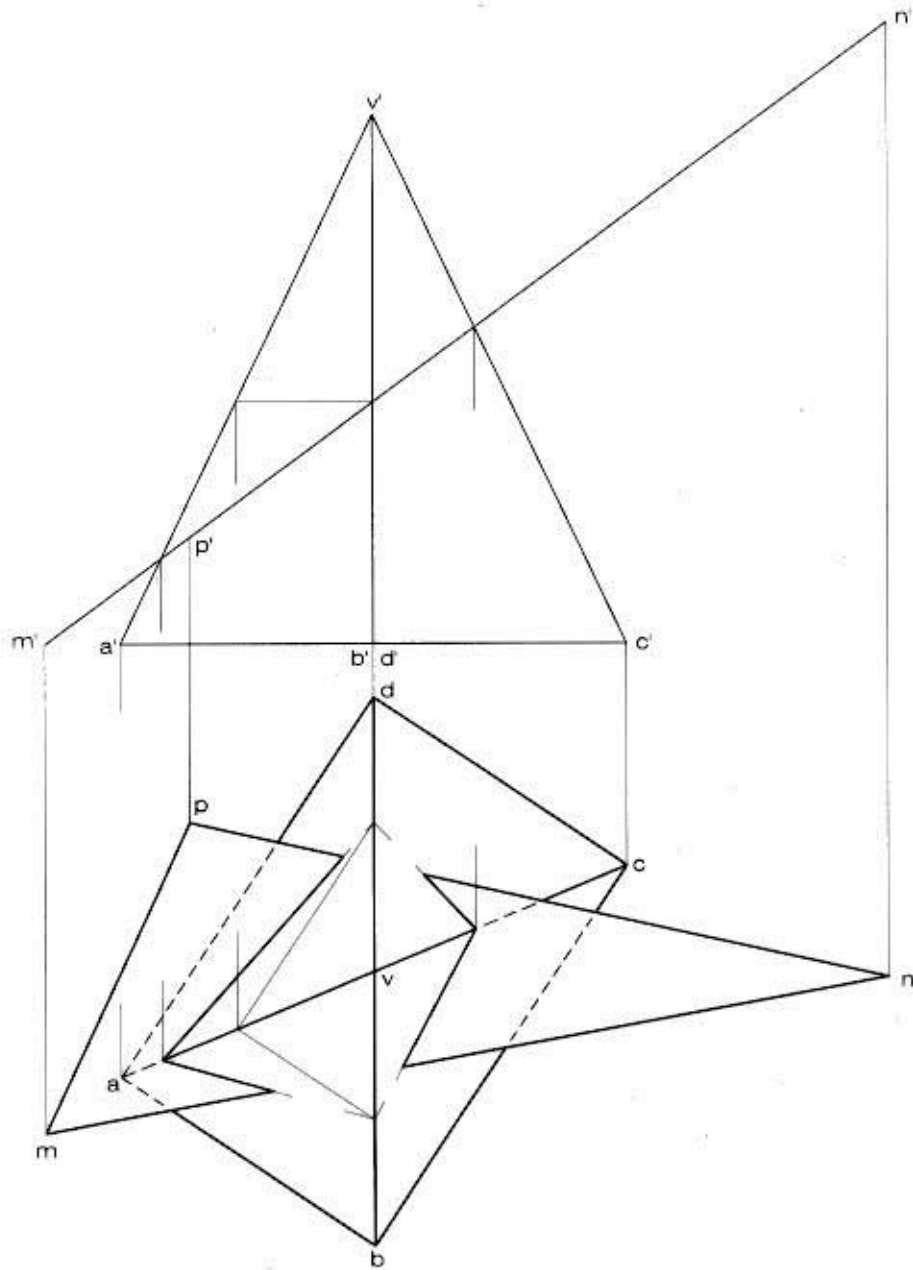

### Exercici 3 Opció A

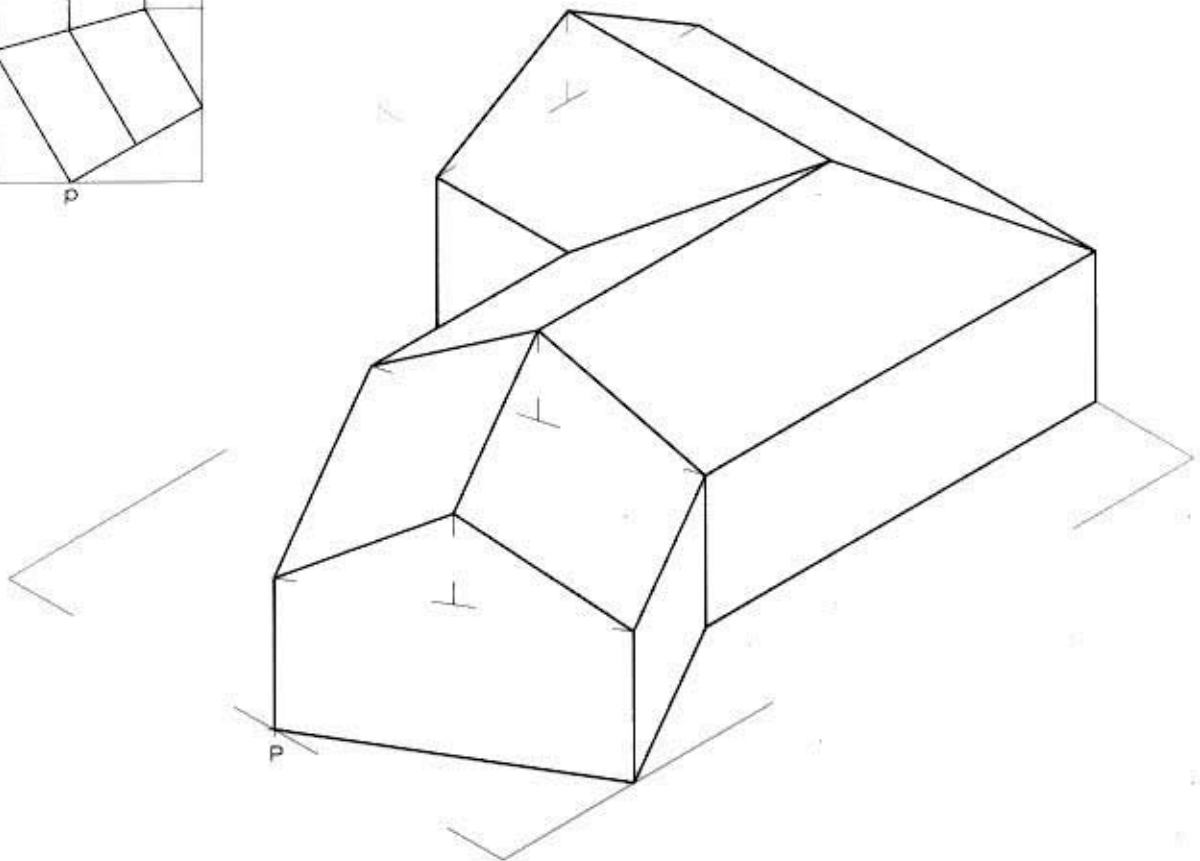
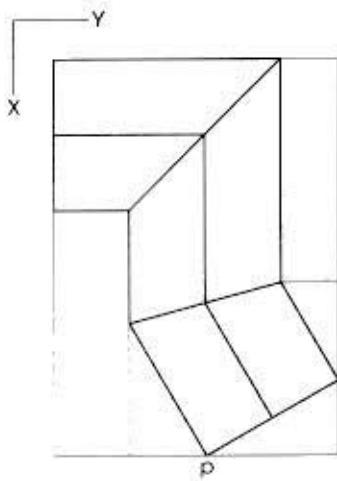
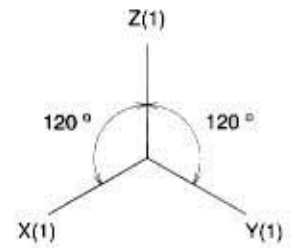
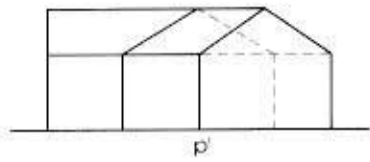

### Exercici 3 Opció B

